



TAVLIT

Quality that lasts

Irrigation and Water Products

2013

For more than 40 years TAVLIT has been supplying high-end and innovative products to leading international companies in the irrigation & water industry and to DIY chains in over 75 countries.

TAVLIT's wide range of products includes plastic filters, valves, a wide range of connectors and irrigation emitters (Foggers, Micro sprinklers), and more. The 2009 purchase of EinDor/Agridor Sprinkler Company greatly expanded our offering.

TAVLIT's years of experience in manufacturing, our team of dedicated design and development engineers, backed by our highly capable in-house mold workshop enables us to respond quickly and efficiently to our customers' requirements, and offer them products that are both user friendly and reliable.

As a quality brand TAVLIT is an ISO 9001:2008 certified for total quality management.

Service

Most of TAVLIT customers and business relationships are decades long and we attribute this loyalty to our dedication to service. At TAVLIT we do our best to fulfill our clients' special requests, whether logistical, technical or product development related. As part of this outlook on the way we do business we also pride ourselves on the fact that most of the TAVLIT team has been with us for many years, some as long as 30 years, servicing our customers.

Our vision

TAVLIT is committed to combine a tradition of quality, service, total personal commitment and responsibility with the ambition to integrate new technologies, innovate



TAVLIT offices and factory, Yavne, Israel

and develop new products that will help the company to service its customers better. We aim to add value to the company and to all our stakeholders: clients, employees, management, owners, suppliers, the community that surrounds us and the world we live in.

Green commitment

As part of the industry that manages our planet's most crucial resource - water, we have a deep understanding of our responsibility to the environment. We take this role beyond the product itself and have embraced social and ecological responsibility within our own company by scrutinizing our waste production and water and energy consumption reducing possible foot print of our production on the environment. In addition we make every effort that our professional and innovative products have a positive effect on global water consumption.



Corporate responsibility

Being a leading company for many years in the water and irrigation industry, Tavlit finds it necessary to invest management efforts and company's resources in corporate social responsibility. From the company's perspective, supporting charitable causes is very important, however it does not suffice in a world in which natural resources are running scarce, Community, economic and social gaps are growing wide and deep. Believing that corporate social responsibility helps us in creating a sustainable, better business, Tavlit holds strong ties with the community - we are implementing a policy of social inclusion and diversity alongside policies of reducing our carbon footprint, running an equal opportunities work environment and supporting our management and employees in their effort to balance work and life.

TAVLIT, A privately held company, was incorporated in 1970 and is now led by Managing Director Yoav Nahmias, 2nd generation to the founding members. TAVLIT's top management team offers a combined experience of dozens of years in the company and the industry.





Swivel Fittings

Materials: Body and swivel: PP | O-Ring: EPDM | Threads: BSPT or NPT

Fertilizer resistant.

Max. working pressure: 10 kg/cm²

TEE M/F			
	Cat. No.	Size	Packing
	STMF1	1"FX1"FX1"M	125
	STMF1A	1"FX1"FX1"M NPT	125
	STMF112	1 1/2"FX1 1/2"FX1 1/2"M	40
	STMF112A	1 1/2"FX1 1/2"FX1 1/2"M NPT	40
	STMF2	2"FX2"FX2"M	25
	STMF2A	2"FX2"FX2"M NPT	25

ELBOW M/F			
	Cat. No.	Size	Packing
	SEFM1	1"FX1"M	250
	SEFM1A	1"FX1"M NPT	250
	SEFM134	1"FX3/4"M	250
	SEFM134A	1"FX3/4"M NPT	250
	SEFM112	1 1/2"FX1 1/2"M	70
	SEFM112A	1 1/2"FX1 1/2"M NPT	70
	SEFM2	2"FX2"M	40
	SEFM2A	2"FX2"M NPT	40

TEE			
	Cat. No.	Size	Packing
	STF1	1"FX1"FX1"F	110
	STF112	1 1/2"FX1 1/2"FX1 1/2"F	35
	STF2	2"FX2"FX2"F	25

COUPLING			
	Cat. No.	Size	Packing
	SFF1	1"FX1"F	250
	SFF1A	1"FX1"F NPT	250

CROSS			
	Cat. No.	Size	Packing
	SCF1	1"FX1"FX1"FX1"F	80
	SCF1A	1"FX1"FX1"FX1"F NPT	80

ADAPTOR M/F			
	Cat. No.	Size	Packing
	SFM34	3/4"FX3/4"M	600
	SFM1	1"FX1"M	300
	SFM1A	1"FX1"M NPT	300
	SFM134	1"FX3/4"M	350
	SFM134A	1"FX3/4"M NPT	350
	SFM112	1 1/2"FX1 1/2"M	120
	SFM112A	1 1/2"FX1 1/2"M NPT	120
	SFM2	2"FX2"M	70
	SFM2A	2"FX2"M NPT	70

CROSS MALE ADAPTOR			
	Cat. No.	Size	Packing
	SCFM1	1"FX1"FX1"FX1"M	100
	SCFM1A	1"FX1"FX1"FX1"M NPT	100
	SCFM134	1"FX1"FX1"FX3/4"M	100
	SCFM134A	1"FX1"FX1"FX3/4"M NPT	100

ELBOW F/F			
	Cat. No.	Size	Packing
	SEF1	1"FX1"F	180
	SEF1A	1"FX1"F NPT	180
	SEF112	1 1/2"FX1 1/2"F	60
	SEF112A	1 1/2"FX1 1/2"F NPT	60
	SEF2	2"FX"F	30
	SEF2A	2"FX"F NPT	30

SWIVEL NIPPLE WITH O-RING			
	Cat. No.	Size	Packing
	N34OR	3/4"X3/4"	500
	N34ORA	3/4"X3/4" NPT	500
	N1OR	1"X1"	400
	N1ORA	1"X1" NPT	400
	N134OR	1"X3/4"	450
	N134ORA	1"X3/4" NPT	450
	N112OR	1 1/2"X1 1/2"	160
	N2OR	2"X2"	100

Special for electric valve assembly. Short thread.



Swivel Fittings

Materials: Body and swivel: PP | O-Ring: EPDM | Threads: BSPT or NPT

Fertilizer resistant.



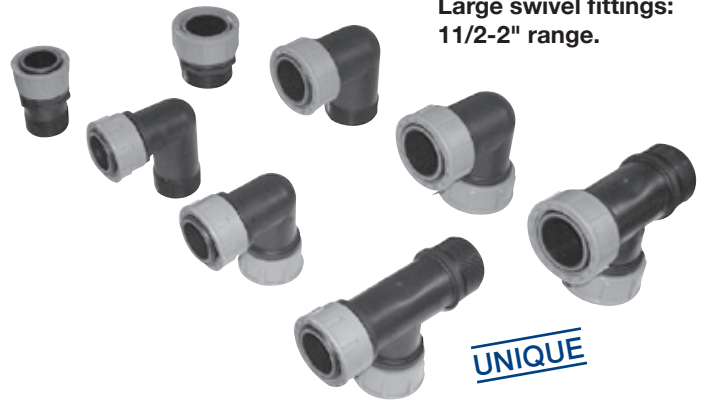

Max. working pressure: 10 kg/cm²

SWIVEL MANIFOLD MALE





	Cat. No.	Size	Packing
	STM12	3X1"FX1"M	60
	STM13	4X1"FX1"M	50
	STM14	5X1"FX1"M	30



SWIVEL MANIFOLD WITH BALL VALVES

	Cat. No.	Size	Packing
	STM1BA	1"FX2X1"M + SWIVEL BALL VALVE 1"	40
	STM12BA	1"FX3X1"M + SWIVEL BALL VALVE 1"	20
	STM13BA	1"FX4X1"M + SWIVEL BALL VALVE 1"	10
	STM14BA	1"FX5X1"M + SWIVEL BALL VALVE 1"	10

SWIVEL MANIFOLD MALE

	Cat. No.	Size	Packing
	STMMF1	1"FX2X1"M	150
	STMMF12	1"FX3X1"M	60
	STMMF13	1"FX4X1"M	50
	STMMF14	1"FX5X1"M	30



Filtration battery flushing manifold



Irrigation cabinets

T NUT LOCK

	Cat. No.	Size	Packing
	STF1NL25	1"FX1"FX25	75

CROSS NUT LOCK

	Cat. No.	Size	Packing
	SCF1NL16	3X1"FX16	75
	SCF1NL20	3X1"FX20	75
	SCF1NL25	3X1"FX25	50

ADAPTOR NUT LOCK

	Cat. No.	Size	Packing
	SFF1NL16	1"FX16	200
	SFF1NL20	1"FX20	200
	SFF1NL25	1"FX25	200

ELBOW NUT LOCK

	Cat. No.	Size	Packing
	SEF1NL16	1"FX16	150
	SEF1NL20	1"FX20	150
	SEF1NL25	1"FX25	100

EITAN Disk and Screen Filters

Features:

- Easy maintenance.
- Unique: swivel quick installation.
- Chemical and fertilizer resistant.
- Interchangeable filtration elements: Disk and Screen elements fit same filter body, with opposite flow direction.

Application:

- Water filtration for Agriculture, landscape, industrial and domestic.













Technical specification:

- Materials: See next page.
- Max. Working pressure: 10kg/cm².
- Threads: B.S.P.T or N.P.T.
- Sizes: 3/4-2".
- Flow rate: 5-20 Cum/h.
- Filtration elements: Disk, Nylon/Stainless steel screen.
- Filtration range: 40-200 mesh.



All filters available in male and swivel connection

FEATURES	Standard				Compact	
	3/4"	1"	1 1/2"	2"	1 1/2"	2"
Flow Rate	5	5	15	20	15	20
Screen Filter Area	140	140	552	670	420	420
Disk Filter Area	180	180	385	488	290	290
Nylon screen Mesh Range	40-200	40-200				
Stainless steel Mesh Range	80-200	80-200	80-200	80-200	80-200	80-200
Disk Mesh Range	80-140	80-140	40-140	40-140	40-140	40-140

ELEMENT TYPE AND MESH COLOR CODE						
Mesh/Micron	40/425	80/200	120/120	140/105	155/90	200/70
Polyester screen	Dark Blue 	Blue 	Brown 		Green 	Violet 
Stainless steel screen		Blue 	Brown 		Green 	Violet 
Disk	Blue 	Yellow 	Red 	Black 		

Mesh count per Linear inch.
Micron in approximate values may vary between element types.

2" swivel disk filter

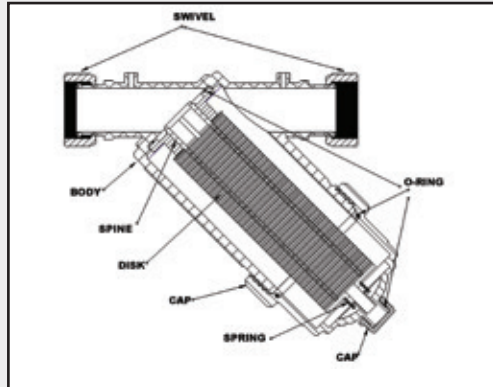

DISK FILTER

Materials:

- Body: P.P.
- Spine: P.P.
- Cup: P.P.
- Disk: P.P.
- Sleeve: P.P.
- Spring: Stainless steel 316.
- O-Rings: EPDM.

1" m/m screen filter

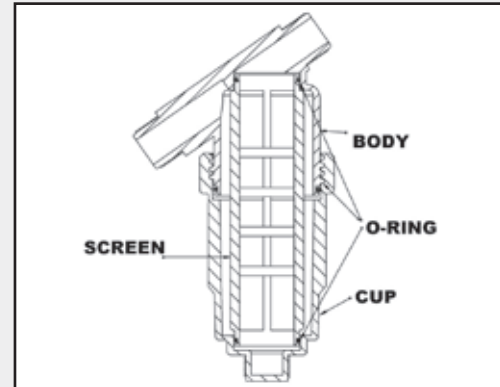

SCREEN FILTER

Materials:

- Body: P.P.
- Screen: Stainless steel or Polyester with P.P. frame
- Cup: P.P.
- O-Rings: EPDM.

Filter ordering guide:

S + F + SIZE + P/S/D + MESH + L/M/B

- S - For swivel filter (optional)
- SIZE - 3/4, 1, 1 1/2, 2"
- P/S/D - P for Polyester screen, S for Stainless steel screen, D for disk filter.
- MESH - filtration range (40-200 See page 7 for availability).
- L/S/M/B - suffix for size category. L for 3/4-1" (screen filter only), M for 1 1/2" and B for 2". S for compact

Example: SF1P120L - 1" Swivel filter 120 mesh Polyester screen.

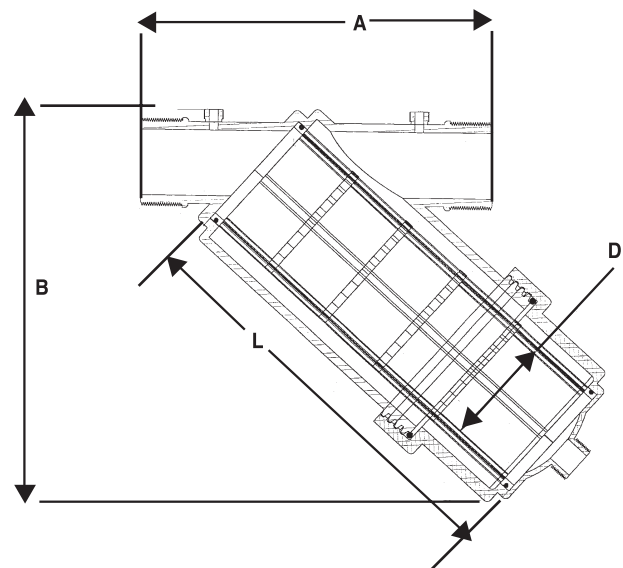

Filter Size	Packing
3/4"-1"	30
1 1/2" compact	10
1 1/2" standard	8
2" compact	10
2" standard	6

Filter Size	Amm	Bmm	Lmm	Dmm
3/4"-1"	121	160	153	31
1 1/2"	257	240	220	80
1 1/2" compact	257	220	170	80
2"	257	270	265	80
2" compact	257	220	170	80

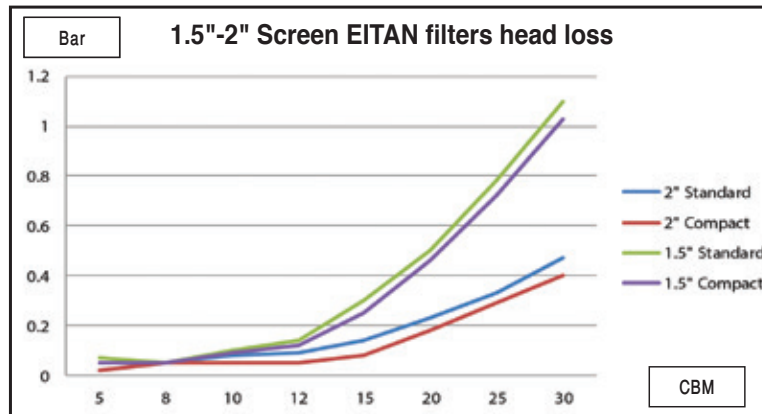
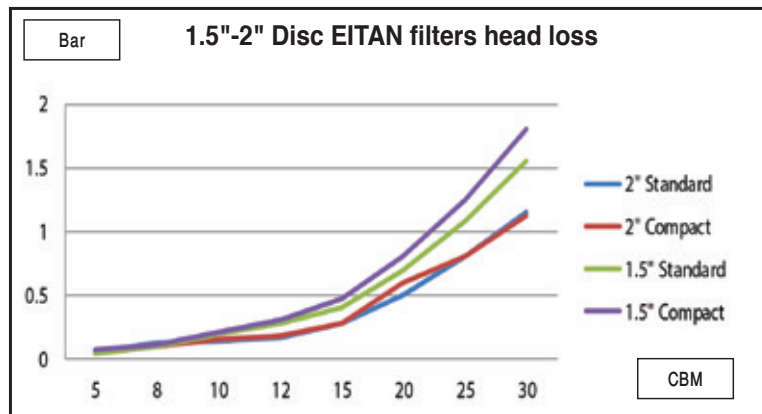
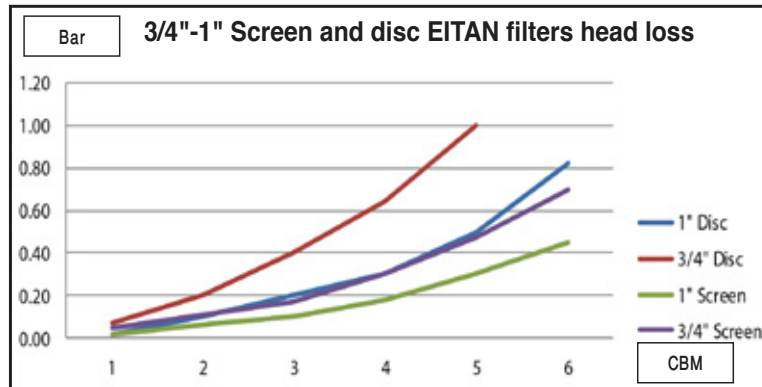

On Line Filter

ON LINE FILTER FEMALE/BARB ADAPTOR			
	Cat. No.	Size	Packing
	FA1234F	12X3/4"F	1200
	FA1634F	16X3/4"F	1000
	FA2034F	20X3/4"F	900

Innox screen 60 mesh

M/F SWIVEL FILTER			
	Cat. No.	Size	Packing
	FSFM34	3/4"X3/4"	550

Innox screen 60 mesh

Ball Valves

Features:

- Designed to resist high working pressure and a wide temperature range.
- Made with Reliability, Long life and durability in mind.
- High chemical resistance.
- Self-Seal Threads.

BALL VALVE F/F			
	Cat. No.	Size	Packing
	BV12F	1/2"FX1/2"F	250
	BV34F	3/4"FX3/4"F	150
	BV1F	1"FX1"F	90
	BV112F	1 1/2"FX1 1/2"F	15
	BV2F	2"FX2"F	15

BALL VALVE F/F T-HANDLE			
	Cat. No.	Size	Packing
	BV12FT	1/2"FX1/2"F	250
	BV34FT	3/4"FX3/4"F	90
	BV1FT	1"FX1"F	100

BALL VALVE M/F			
	Cat. No.	Size	Packing
	BV12FM	1/2"FX1/2"M	250
	BV34FM	3/4"FX3/4"M	150
	BV1FM	1"FX1"M	90
	BV112FM	1 1/2"FX1 1/2"M	15
	BV2FM	2"FX2"M	15

BALL VALVE M/F T-HANDLE			
	Cat. No.	Size	Packing
	BV12FMT	1/2"FX1/2"M	250
	BV34FMT	3/4"FX3/4"M	150
	BV1FMT	1"FX1"M	90

SWIVEL BALL VALVE F/F T-HANDLE			
	Cat. No.	Size	Packing
	SBV34FTS	3/4"FX3/4"F	150
	SBV1FTS	1"FX1"F	90

Technical specification:

- Materials: See below.
- Max. Working pressure: 16kgs/cm².
- Temperature range: -20°C to 90°C.
- Threads: BSPP

SWIVEL BALL VALVE F/F			
	Cat. No.	Size	Packing
	SBV34F	3/4"FX3/4"F	150
	SBV1F	1"FX1"F	90
	SBV112F	1 1/2"FX1 1/2"M	15
	SBV2F	2"FX2"M	15

SWIVEL BALL VALVE F/F			
	Cat. No.	Size	Packing
	SBV34FT	3/4"FX3/4"F	150
	SBV1FT	1"FX1"F	90

SWIVEL/MALE			
	Cat. No.	Size	Packing
	SBV34FMT	3/4"MX3/4"F	150
	SBV1FMT	1"FX1"M	90
	SBV112FM	1 1/2"FX1 1/2"M	15
	SBV2FM	2"FX2"M	15

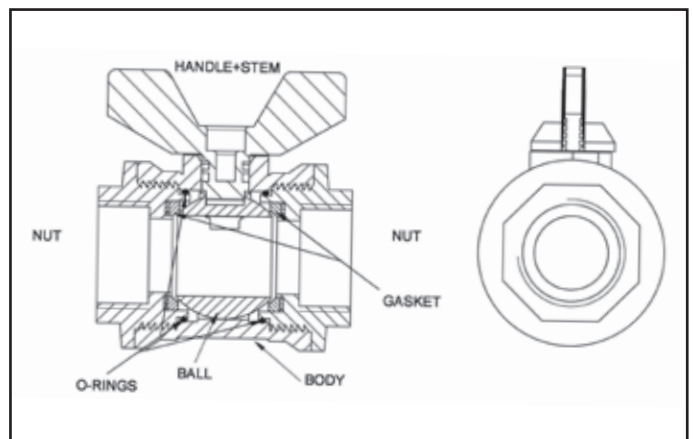

Materials:

- Body: P.P. with GF
- Nut: P.P. with GF
- Handle: Polyamid with GF
- Ball: Polyamid 12.
- Gasket: VITON.
- O-Rings: EPDM.

THREAD-LOCK SADDLE CLAMP

Materials: PP | O-Ring: EPDM | Threads: BSPT

Fertilizer resistant.

Max. working pressure: 10 kg/cm²

Features:

- High pressure saddles without bolts
- Unique design – patent pending
- Save time – quick and easy assembly and maintenance
- Install without tools
- No metal parts = no corrosion

UNIQUE

- Available in self seal version – add "S" to cat code
- Available with Stainless steel rings – add "R" to cat code

Single outlet

	Cat. No.	Size	Packing
	SAD2012	20 x 1/2"	200
	SAD2512	25 x 1/2"	140
	SAD2534	25 x 3/4"	140
	SAD3212	32 x 1/2"	90
	SAD3234	32 x 3/4"	90
	SAD321	32 x 1"	90
	SAD4012	40 x 1/2"	70
	SAD4034	40 x 3/4"	70
	SAD401	40 x 1"	70
	SAD5012	50 x 1/2"	60
	SAD5034	50 x 3/4"	60
	SAD501	50 x 1"	60
	SAD6312	63 x 1 1/2"	30
	SAD6334	63 x 3/4"	30
	SAD631	63 x 1"	30
	SAD63112	63 x 1 1/2"	30
SAD7534	75 x 3/4"	25	

Double outlet

	Cat. No.	Size	Packing
	SAD2012D	20 x 1/2"	160
	SAD2512D	25 x 1/2"	110
	SAD2534D	25 x 3/4"	110
	SAD3212D	32 x 1/2"	70
	SAD3234D	32 x 3/4"	70
	SAD321D	32 x 1"	70
	SAD4012D	40 x 1/2"	55
	SAD4034D	40 x 3/4"	55
	SAD401D	40 x 1"	55
	SAD5012D	50 x 1/2"	45
	SAD5034D	50 x 3/4"	45
	SAD501D	50 x 1"	45
	SAD6312D	63 x 1/2"	25
	SAD6334D	63 x 3/4"	25
	SAD631D	63 x 1"	25
	SAD63112D	63 x 1 1/2"	25
SAD7534D	75 x 3/4"	20	

Quick Assembly

1

Place the lower part of the saddle below the pipe and hold it in position.

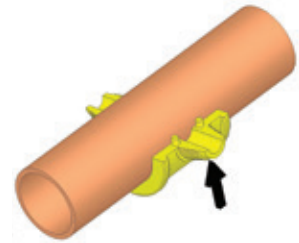

2

Place the upper part of the saddle on top of the pipe. Align the holes in the upper part with the pins in the lower part. Hold the two pieces of the saddle together roughly parallel to each other.

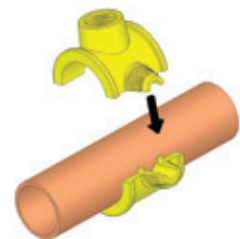

3

Thread the first wing nut onto the start of the thread about 1-1½ turns. Continue holding the parts of the saddle parallel to each other.

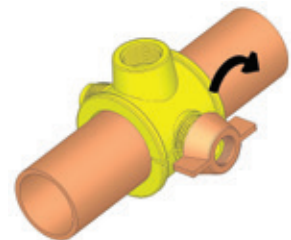

4

Thread the second wing nut onto the start of the thread about 1-1½ turns. You may now release the two parts of the saddle clamp.

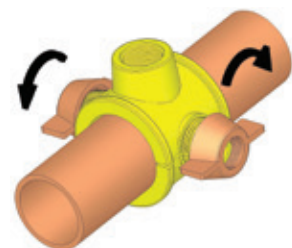

5

Thread both wing nuts simultaneously and tighten.

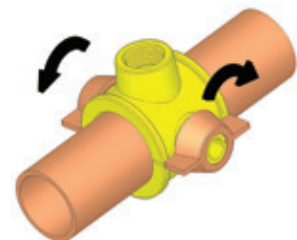

The Saddle is now ready to use. Drill the hole in the pipe through the saddle outlet. Make certain you do not damage the threads.



Fertilizer resistant.

All 16 also fit 17.

16-17mm: 0.7 - 1.5mm wall thickness.
 20mm: 0.9 - 2.0mm wall thickness.
 25mm: 1.4 - 2.0mm wall thickness.

All nut lock fittings available in American 1/2" (16-18mm) pipe diameter.
 Add "A" to cat code of 16 nut locks for American version.

END LINE

	Cat. No.	Size	Packing
	NLP16	16	500
	NLP20	20	450
	NLP25	25	275

T-SWIVEL FEMALE

	Cat. No.	Size	Packing
	NLT1634S	16X3/4"FX16	125
	NLT2034S	20X3/4"FX20	125
	NLT251S	25X 1"FX25	75

COUPLING

	Cat. No.	Size	Packing
	NL16	16x16	250
	NL20	20X20	250
	NL25	25X25	175
	NL2016	20X16	250
	NL2025	20X25	200
	NL1625	16X25	175

T-MALE THREAD

	Cat. No.	Size	Packing
	NLT1612M	16X1/2"X16	175
	NLT1634M	16X3/4"X16	150
	NLT2012M	20X1/2"X20	150
	NLT2034M	20X3/4"X20	150
	NLT2512M	25X1/2"X25	100
	NLT2534M	25X3/4"X25	100
	NLT161M	16X 1"X16	80
	NLT201M	20X 1"X20	80
	NLT251M	25X 1"X25	80

MALE THREAD

	Cat. No.	Size	Packing
	NL1612M	16X1/2"M	400
	NL1634M	16X3/4"M	400
	NL2012M	20X1/2"M	400
	NL2034M	20X3/4"M	400
	NL2534M	25X3/4"M	250
	NL251M	25X1"M	250

ELBOW MALE THREAD

	Cat. No.	Size	Packing
	NLE1612M	16X1/2"M	300
	NLE2012M	20X1/2"M	300
	NLE1634M	16X3/4"M	300
	NLE2034M	20X3/4"M	275
	NLE2512M	25X1/2"M	175
	NLE2534M	25X3/4"M	175
	NLE161M	16X 1"M	150
	NLE201M	20X 1"M	150
	NLE251M	25X 1"M	150

FEMALE THREAD

	Cat. No.	Size	Packing
	NL1634F	16X3/4"F	300
	NL2034F	20X3/4"F	300
	NL251F	25X 1"F	200
	NL1634S	16X3/4"F (Swivel)	300
	NL2034S	20X3/4"F (Swivel)	300

ELBOW

	Cat. No.	Size	Packing
	NLE16	16X16	200
	NLE20	20X20	200
	NLE25	25X25	100
	NLE2016	16X20	200
	NLE2520	20X25	150
	NLE2516	16X25	150

TEE

	Cat. No.	Size	Packing
	NLT16	16X16X16	125
	NLT20	20X20X20	125
	NLT25	25X25X25	75
	NLT1620	16X20X16	125
	NLT2016	20X16X20	125
	NLT2025	20X25X20	100
	NLT1625	16X25X16	100
	NLT2520	25X20X25	75
	NLT2516	25X16X25	75

ELBOW SWIVEL FEMALE

	Cat. No.	Size	Packing
	NLE1634S	16X3/4"F	200
	NLE2034S	20X3/4"F	200
	NLE251S	25X1"F	150

Nut Lock Fitting parts | Materials: Body and nut - PP | Grip - PBT | Threads: BSPT

Fertilizer resistant.

Max. working pressure: 10 kg/cm²

TEE SWIVEL FEMALE - BODY			
	Cat. No.	Size	Packing
	NLT34S	3/4"MX3/4"FX3/4"M	280
	NLT1S	1"MX 1"F X 1"M	150

COUPLING - BODY			
	Cat. No.	Size	Packing
	N34	3/4"	750
	N1	1"	400
	N134	1"X3/4"	500
	N1234	3/4"X1/2"	800

ELBOW SWIVEL FEMALE - BODY			
	Cat. No.	Size	Packing
	NLE34S	3/4" M/F	400
	NLE1S	1" M/F	250
	NLE134S	1"FX3/4" M	250

END LINE - BODY			
	Cat. No.	Size	Packing
	PM34	3/4"	1100
	PM1	1"	650

ELBOW - BODY			
	Cat. No.	Size	Packing
	NLE34M	3/4"	500
	NLE1M	1"	300
	NLE134M	1"X3/4"	300
	NLE3412M	3/4"X1/2"	500
	NLE1012M	1"X1/2"	350

NUT			
	Cat. No.	Size	Packing
	NLF16	16-17	900
	NLF1618	16-18 (American 1/2")	900
	NLF20	20	800
	NLF25	25	500

T - BODY			
	Cat. No.	Size	Packing
	NLT34M	3/4"X3/4"X3/4"	300
	NLT1M	1"X1"X1"	180
	NLT3412M	3/4"X1/2"X3/4"	300
	NLT134M	1"X3/4"X1"	180
	NLT341M	3/4"X1"X3/4"	250
	NLT1012M	1"X1/2"X1"	200

GRIP			
	Cat. No.	Size	Packing
	NLG16	16-17	3200
	NLG1618	16-18 (American 1/2")	3200
	NLG20	20	2800
	NLG25	25	1500

Fertilizer resistant.

Tavlit threaded fittings range is available with the unique self seal system (pre-assembled o-rings) that saves labor and Teflon, and allows tightening without tools.

For self seal version of product add "S" to catalog code.

NIPPLE

	Cat. No.	Size	Packing
	N12	1/2"X1/2"	1200
	N34	3/4"X3/4"	750
	N1	1"X1"	400
	N114	1 1/4"X1 1/4"	240
	N112	1 1/2"X1 1/2"	180
	N2	2"X2"	110

REDUCTION FEMALE COUPLING

	Cat. No.	Size	Packing
	FC1234	1/2"X3/4"	600
	FC134	1"X3/4"	350
	FC1114	1 1/4"X1"	280
	FC1112	1"X1 1/2"	210
	FC11234	3/4"X1 1/2"	210
	FC112114	1 1/2"X1 1/4"	160
	FC234	2"X3/4"	130
	FC21	2"X1"	130
	FC2114	2"X1 1/4"	130
	FC2112	2"X1 1/2"	110

REDUCTION NIPPLE

	Cat. No.	Size	Packing
	N1234	1/2"X3/4"	800
	N1012	1"X1/2"	500
	N134	1"X3/4"	500
	N1114	1"X1 1/4"	270
	N1112	1"X1 1/2"	220
	N11212	1 1/2"X1 1/2"	250
	N11434	3/4"X1 1/4"	300
	N114112	1 1/4"X1 1/2"	200
	N21	2"X1"	150
	N2114	2"X1 1/4"	140
	N2112	2"X1 1/2"	130

BUSHING MALE/FEMALE

	Cat. No.	Size	Packing
	BMF3412	3/4"MX1/2"F	1400
	BMF1012	1"MX1/2"F	800
	BMF134	1"MX3/4"F	800
	BMF11412	1 1/4"MX1/2"F	600
	BMF11434	1 1/4"MX3/4"F	500
	BMF1141	1 1/4"MX1"F	500
	BMF11212	1 1/2"MX1/2"F	400
	BMF11234	1 1/2"MX3/4"F	400
	BMF1121	1 1/2"MX1"F	400
	BMF112114	1 1/2"MX1 1/4"F	400
	BMF212	2"MX1/2"F	280
	BMF234	2"MX3/4"F	280
	BMF21	2"MX1"F	280
	BMF2114	2"MX1 1/4"F	280
	BMF2112	2"MX1 1/2"F	280

PLUG

	Cat. No.	Size	Packing
	PM12	1/2"	1500
	PM34	3/4"	1100
	PM1	1"	650
	PM114	1 1/4"	360
	PM112	1 1/2"	280
	PM2	2"	200

BUSHING FEMALE/MALE

	Cat. No.	Size	Packing
	BFM3412	1/2"MX3/4"F	700
	BFM34	3/4"MX3/4"F	500
	BFM1	1"MX1"F	360
	BFM1012	1/2"MX1"F	400
	BFM134	3/4"MX1"F	400
	BFM112	1 1/2"MX1 1/2"F	180
	BFM11234	3/4"MX1 1/2"F	200
	BFM1121	1"MX1 1/2"F	200
	BFM1141	1"MX1 1/4"F	280
	BFM11412	1 1/2"MX1 1/4"F	300
	BFM11434	3/4"MX1 1/4"F	300
	BFM112114	1 1/4"MX1 1/2"F	200
	BFM234	3/4"MX2"F	150
	BFM21	1"MX2"F	150
	BFM2	2"MX2"F	120
	BFM2112	1 1/2"MX2"F	130

FEMALE COUPLING

	Cat. No.	Size	Packing
	FC12	1/2"X1/2"	900
	FC34	3/4"X3/4"	500
	FC1	1"X1"	350
	FC114	1 1/4"X1 1/4"	210
	FC112	1 1/2"X1 1/2"	160
	FC2	2"X2"	100

Threaded Fitting

Materials: PP | Threads: BSPT | Max. working pressure: 16 kg/cm²

Fertilizer resistant.

Tavlit threaded fittings range is available with the unique self seal system (pre-assembled o-rings) that saves labor and Teflon, and allows tightening without tools.

For self seal version of product add "S" to catalog code.

CAP			
	Cat. No.	Size	Packing
	CF12	1/2"	2600
	CF34	3/4"	1300
	CF1	1"	700
	CF34A	3/4" NPT	1300
	CF1A	1" NPT	700
	CF114	1 1/4"	450
	CF112	1 1/2"	300
	CF2	2"	160

ELBOW MALE THREAD			
	Cat. No.	Size	Packing
	NLE34M	3/4"X3/4"	500
	NLE1M	1"X1"	300
	NLE134M	1"X3/4"	300
	NLE3412M	3/4"X1/2"	500
	NLE1012M	1"X1/2"	350

T FEMALE THREAD			
	Cat. No.	Size	Packing
	TF12	1/2"X1/2"X1/2"	400
	TF34	3/4"X3/4"X3/4"	200
	TF1	1"X1"X1"	150
	TF114	1 1/4"X1 1/4"X1 1/4"	70
	TF112	1 1/2"X1 1/2"X1 1/2"	60
	TF2	2"X2"X2"	40

T MALE THREAD			
	Cat. No.	Size	Packing
	NLT34M	3/4"X3/4"X3/4"	300
	NLT1M	1"X1"X1"	180
	NLT3412M	3/4"X1/2"X3/4"	300
	NLT134M	1"X3/4"X1"	180
	NLT341M	3/4"X1"X3/4"	250
NLT1012M	1"X1/2"X1"	125	

ELBOW FEMALE THREAD			
	Cat. No.	Size	Packing
	EF12	1/2"X1/2"	600
	EF34	3/4"X3/4"	300
	EF1	1"X1"	230
	EF114	1 1/4"X1 1/4"	100
	EF112	1 1/2"X1 1/2"	80
	EF2	2"X2"	48

TEE SWIVEL FEMALE			
	Cat. No.	Size	Packing
	NLT34S	3/4"MX3/4"FX3/4"M	280
	NLT1S	1"MX 1" F X 1" M	150

ELBOW MALE/FEMALE THREAD			
	Cat. No.	Size	Packing
	EMF12	1/2"MX1/2"F	600
	EMF34	3/4"MX3/4"F	400
	EMF1	1"MX1"F	250

ELBOW SWIVEL FEMALE			
	Cat. No.	Size	Packing
	NLE34S	3/4" M/F	400
	NLE1S	1" M/F	250

PLUG O-RING			
	Cat. No.	Size	Packing
	PM34OR	3/4"	1600
	PM112OR	1 1/2"	300
	PM2OR	2"	250

- Special use.
- Shoulder o-ring seat.
- Short thread.

Threaded Fittings-Self Seal | Materials: PP | O-Ring: EPDM | Threads: BSPT

Fertilizer resistant.

Max. working pressure: 16 kg/cm²

Available for all Tavlit threaded fittings range

1. Save labour and teflon tape
2. Tighten by hand only
3. Full proof using our male to female assembly
4. Add "s" to threaded fittings cat. No. for Self-Seal
5. EPDM o-ring - Fertilizer resistant

For self seal version of product add "S" to catalog code.

UNIQUE

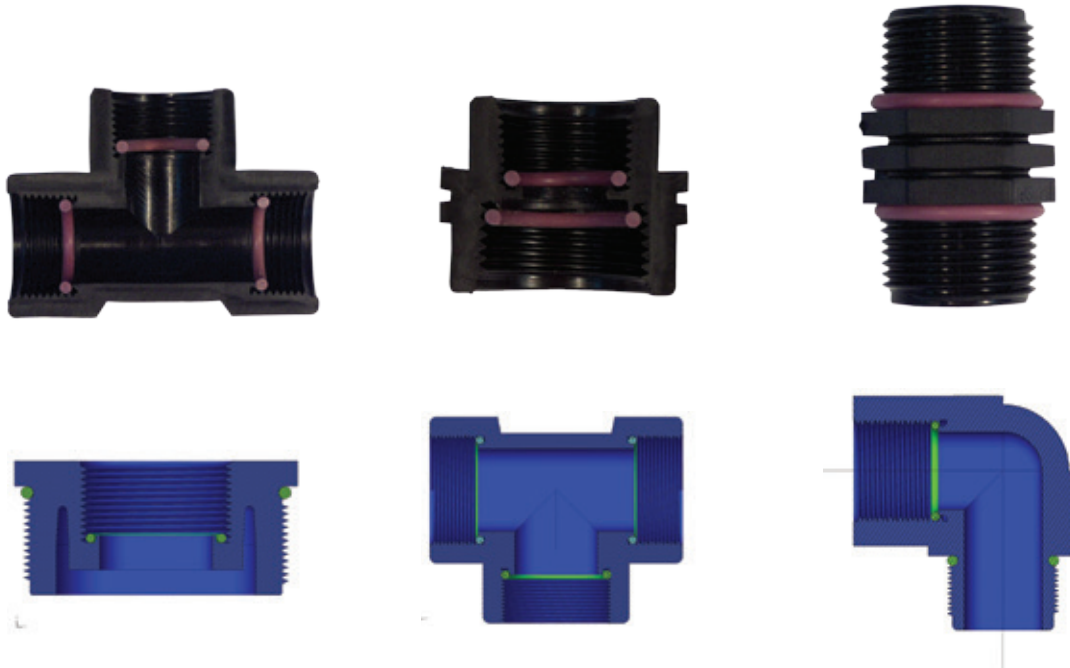

Self Seal Assembly

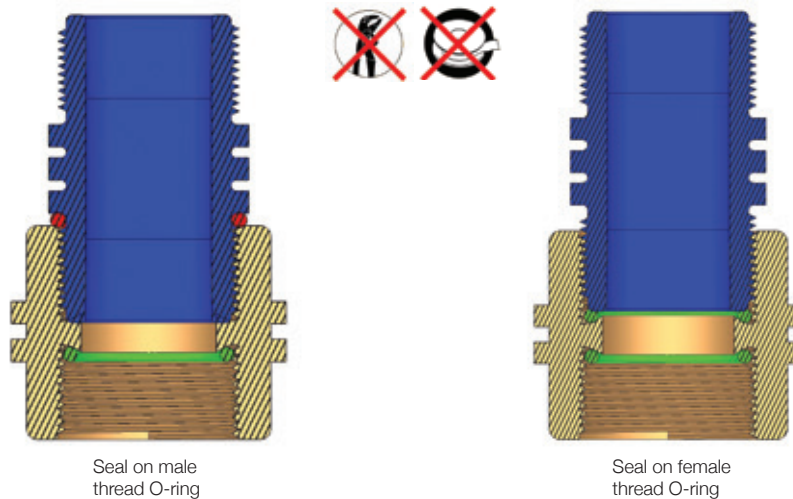



Barb Connectors | Materials: Acetal | Threads: BSPT or NPT | Max. working pressure: 8 kg/cm²

Standard color: 12, 16, 20, 25 - black; 17 - brown;
other colors and raw materials available on special request.

Barb connectors sizes are compatible with pipe outer diameter.

Minimum wall thickness:
12mm - 0.7mm
16-17mm, 20mm - 0.9mm
25mm - 1.4mm

COUPLING

	Cat. No.	Size	Packing
	C12	12X12	3200
	C16	16X16	2200
	C1612	12X16	2200
	C17	17X17	2200
	C1712	12X17	2400
	C1617	16X17	2200
	C20	20X20	1300
	C2012	12X20	1500
	C2016	16X20	1400
	C2017	17X20	1800
	C25	25X25	900
	C2517	17X25	1200
	C2520	20X25	1000

ELBOW

	Cat. No.	Size	Packing
	E12	12X12	4000
	E16	16X16	1800
	E17	17X17	1800
	E20	20X20	900
	E25	25X25	800

T CONNECTOR

	Cat. No.	Size	Packing
	TC12	12X12X12	2500
	TC1216	12X16X12	1800
	TC16	16X16X16	1000
	TC1612	16X12X16	1100
	TC1620	16X20X16	900
	TC17	17X17X17	1000
	TC1716	17X16X17	1200
	TC20	20X20X20	650
	TC2012	20X12X20	650
	TC2016	20X16X20	650
	TC25	25X25X25	550
	TC2520	25X20X25	600

MALE ADAPTOR

	Cat. No.	Size	Packing
	MA1212	12x1/2"	1400
	MA1234	12X3/4"	1100
	MA1612	16X1/2"	1200
	MA1634	16X3/4"	900
	MA1712	17X1/2"	1600
	MA1734	17X3/4"	1300
	MA2012	20X1/2"	1500
	MA2034	20X3/4"	800
	MA2512	25X1/2"	1000
	MA2534	25X3/4"	900

END LINE PLUG

	Cat. No.	Size	Packing
	ELP12	12mm	6000
	ELP16	16mm	3000
	ELP17	17mm	5000
	ELP20	20mm	3600

END LINE 8 FIGURE

	Cat. No.	Size	Packing
	ELP16E	16	2500
	ELP20E	20	1400

ELBOW MALE ADAPTOR

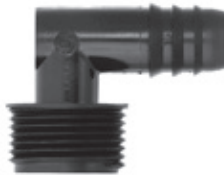
	Cat. No.	Size	Packing
	ME1212	12X1/2"	1600
	ME1234	12X3/4"	1400
	ME1612	16X1/2"	1600
	ME1634	16X3/4"	1300
	ME1712	17X1/2"	1600
	ME1734	17X3/4"	1300
	ME2012	20X1/2"	900
	ME2034	20X3/4"	700
	ME2512	25X1/2"	900
	ME2534	25X3/4"	600

FEMALE ADAPTOR

	Cat. No.	Size	Packing
	FA1234	12X3/4"	1200
	FA1634	16X3/4"	1000
	FA2034	20X3/4"	900

T CONNECTOR MALE THREAD

	Cat. No.	Size	Packing
	TM1212	12X1/2"X12	1400
	TM1234	12X3/4"X12	1100
	TM1612	16X1/2"X16	1100
	TM1634	16X3/4"X16	850
	TM1712	17X1/2"X17	1000
	TM1734	17X3/4"X17	850
	TM2012	20X1/2"X20	650
	TM2034	20X3/4"X20	550
	TM2512	25X1/2"X25	600
	TM2534	25X3/4"X25	450

CROSS CONNECTOR			
	Cat. No.	Size	Packing
	CX12	12X12X12X12	1800
	CX16	16X16X16X16	800
	CX17	17X17X17X17	800

FEMALE (T) CONNECTOR			
	Cat. No.	Size	Packing
	TF1234	12X2X3/4"	500
	TF1634	16X2X3/4"	400
	TF1734	17X2X3/4"	360
	TF171	17X2X1"	360
	TF2034	20X2X3/4"	350
	TF201	20X2X1"	300

STAR CONNECTOR			
	Cat. No.	Size	Packing
	C316	16X16X16 (Y)	1400
	C317	17X17X17 (Y)	1000
	C320	20x20x20 (Y)	550

FEMALE THREE CONNECTOR			
	Cat. No.	Size	Packing
	TCF1234	12X3X3/4"	400
	TCF1634	16X3X3/4"	360
	TCF1734	17X3X3/4"	300
	TCF171	17X3X1"	300
	TCF2034	20X3X3/4"	260
	TCF201	20X3X1"	260

FORK CONNECTOR			
	Cat. No.	Size	Packing
	TRC12	12X3/4"M	600
	TRC16	16X3/4"M	500
	TRC17	17X3/4"M	450
	TRC20	20X3/4"M	400

FEMALE FOUR CONNECTOR			
	Cat. No.	Size	Packing
	FCF1234	12X4X3/4"	360
	FCF1634	16X4X3/4"	300
	FCF1734	17X4X3/4"	250
	FCF2034	20X4X3/4"	200
	FCF201	20X4X1"	200

Y CONNECTOR			
	Cat. No.	Size	Packing
	YC12	12X3/4"	700
	YC16	16X3/4"	600
	YC17	17X3/4"	600
	YC20	20X3/4"	500

FEMALE SIX CONNECTOR			
	Cat. No.	Size	Packing
	SCF1234	12X6X3/4"	280
	SCF1634	16X6X3/4"	220
	SCF1734	17X6X3/4"	200
	SCF171	17X6X1"	200
	SCF2034	20X6X3/4"	150
	SCF201	20X6X1"	150



Various colors - by special order

Purple - for mining applications
Chemical resistant

Drip Tape - Nut Connectors

Materials: Acetal for barb body | PP for other body | PP for nut

Max. working pressure: 8 kg/cm² | Threads: BSPT, NPT or MHT

For driptape with or without seam. Wall thickness: 16;17 mm – 4 - 45 mil (0.1 - 1.1 mm) 22;25 mm – 6 - 25 mil (0.15 - 0.65 mm)

MALE ADAPTOR			
	Cat. No.	Size	Packing
	MA12TA	16;17X1/2"	900
	MA34TA	16;17X3/4"	700
	MA34TA22	22X3/4"	500
	MA34TA25	25X3/4"	350

COUPLING			
	Cat. No.	Size	Packing
	CTT	16;17X16;17	700
	CTT22	22X22	350
	CTT25	25X25	350

END LINE			
	Cat. No.	Size	Packing
	ELPTA	16;17	1300

BARB ADAPTOR			
	Cat. No.	Size	Packing
	TA1617	16;17X16;17 Barb	900
	TA2220	22X20 Barb	500
	TA2525	25X25 Barb	350

T MALE ADAPTOR			
	Cat. No.	Size	Packing
	TMTA12	16,17 x 1/2" M x 16,17	450
	TMTA2212	22 x 1/2" M x 22	300

LAY FLAT STARTER			
	Cat. No.	Size	Packing
	LFTA	16;17	900
	LFTA22	22	400

ELBOW MALE ADAPTOR			
	Cat. No.	Size	Packing
	META12	16,17 x 1/2" M	800
	META2212	22 x 1/2" M	450

STICK STARTER			
	Cat. No.	Size	Packing
	STTA	16;17	1200
	STTAGR	16;17 Inc. G-ST	1000
	STTA22	22	700
	STTA22GR	22 Inc. G-ST	600

T BARB ADAPTOR			
	Cat. No.	Size	Packing
	TTA16	16,17 x 16 barb x 16,17	500
	TTA2220	22 x 20 barb x 22	400

PVC STARTER			
	Cat. No.	Size	Packing
	GSTA	16;17 Inc. G-16	750

Drip Tape Ring Connectors

Materials: Acetal for barb body | PP for other body | PP for ring

Max. working pressure: 8 kg/cm² | Threads: BSPT or NPT

Flat Ring

For driptape 16mm to 17mm O.D. - without seam
Black ring - wall thickness 6mil to 25mil (0.15-0.65mm)

Brown ring - wall thickness 35mil to 45mil (0.8-1.1mm)
User Friendly – for easy assembly

COUPLING				
	Cat. No.	Size	Ring	Packing
	TWT	16.5X16.5	Black	1200
	MW16	16;17X16;17	Brown	1200

BARB ADAPTOR				
	Cat. No.	Size	Ring	Packing
	TWT16	16 BarbX16.5	Black	1500
	TWT17	17 BarbX16.5	Black	1500
	MW16B	16 BarbX16;17	Brown	1500
	MW17B	17 BarbX16;17	Brown	1500

MALE ADAPTOR				
	Cat. No.	Size	Ring	Packing
	TWT12	16.5X1/2"	Black	1100
	TWT34	16.5X3/4"	Black	950
	MW1612	16;17X1/2"	Brown	1100
	MW1634	16;17X3/4"	Brown	950

END LINE				
	Cat. No.	Size	Ring	Packing
	TWELT	16.5	Black	3000
	MWEL1617	16;17	Brown	3000

ELBOW CONNECTOR				
	Cat. No.	Size	Ring	Packing
	ET16	16 BarbX16.5	Black	1500
	ET17	17 BarbX16.5	Black	1300
	EMW16	16 BarbX16;17	Brown	1500
	EMW17	17 BarbX16;17	Brown	1300

(T) CONNECTOR				
	Cat. No.	Size	Ring	Packing
	TCT16	16.5X16 BarbX16.5	Black	1000
	TCT17	16.5X17 BarbX16.5	Black	900
	TCT20	16.5X20 BarbX16.5	Black	800
	TCMW16	16;17X16 BarbX16	Brown	1000
	TCMW17	16;17X17 BarbX17	Brown	900
	TCMW20	16;17X20 BarbX16	Brown	800

Drip Tape - Ring Connectors

Materials: Acetal for barb body | PP for other body | PP for nut

Max. working pressure: 8 kg/cm² | Threads: BSPT, NPT or MHT

Long Ring

For driptape without seam

Wall thickness:

12;16 mm – black ring (0.15-0.65 mm)

COUPLING

	Cat. No.	Size	Packing
	TW12L	12x12	2400
	TWTL	16.5x16.5	1200

BARB ADAPTOR

	Cat. No.	Size	Packing
	TWB1212L	12 BARB x 12mm	1500
	TWT16L	16 BARB x 16.5mm	1500
	TWT17L	17 BARB x 16.5mm	1500

STICK START CONNECTOR

	Cat. No.	Size	Packing
	STTW12L	12mm	2000
	STTWL	16.5mm	1800

END LINE

	Cat. No.	Size	Packing
	TWEL12L	12mm	3000
	TWELTL	16.5mm	3000

MALE ADAPTOR

	Cat. No.	Size	Packing
	TWM1212L	12mm x 1/2m	1500
	TWT12L	16.5mm x 1/2m	1100
	TWT34L	16.5mm x 3/4m	950

(T) CONNECTOR

	Cat. No.	Size	Packing
	TCT16L	16.5x16 BARBx16.5	1000
	TCT17L	16.5x17 BARBx16.5	900
	TCT20L	16.5x20 BARBx16.5	800

ELBOW CONNECTOR

	Cat. No.	Size	Packing
	ET16L	16 BARB x 16.5mm	1500
	ET17L	17 BARB x 16.5mm	1300

ELBOW MALE ADAPTOR

	Cat. No.	Size	Packing
	TWEM1212L	12mm	1500

MALE T CONNECTOR

	Cat. No.	Size	Packing
	TWTM1212L	12MM x 1/2M x 12MM	1000

FEMALE (T) CONNECTOR

	Cat. No.	Size	Packing
	TWT234L	16.5 x 2X 3/4F	300

FEMALE FOUR CONNECTOR

	Cat. No.	Size	Packing
	TWT434L	16.5 x 4X 3/4F	250

FEMALE SIX CONNECTOR

	Cat. No.	Size	Packing
	TWT634L	16.5 x 6X 3/4F	150



Wall thickness for nut lock valves:

16-17mm: 0.7 - 1.5mm
 20mm: 0.9 - 2.0mm
 25mm: 1.4 - 2.0mm

Minimum wall thickness for barb connector valves:

12mm: 0.7mm
 16, 17, 20mm: 0.9mm
 25mm: 1.4mm

BARB COUPLING

	Cat. No.	Size	Packing
	V12	12X12	400
	V16	16X16	400
	V17	17X17	400
	V20	20X20	350
	V2016	20X16	400
	V25	25X25	300
	V2516	25X16	300
	V2520	25X20	300
	V13	13 ID x 13 ID	400
	V19	19 ID x 19 ID	350

ELBOW WITH HOOK

	Cat. No.	Size	Packing
	VE16H	16X16	330
	VE17H	17X17	330
	VE20H	20X20	330

MALE/MALE

	Cat. No.	Size	Packing
	VMM12	1/2"MX1/2"M	360
	VMM34	3/4"MX3/4"M	280
	VMM3412	3/4"MX1/2"M	300

NUT LOCK

	Cat. No.	Size	Packing
	V16NL	16X16	150
	V20NL	20X20	150
	V2016NL	20X16	150

MALE/FEMALE

	Cat. No.	Size	Packing
	VMF1234	1/2"MX3/4"F	300
	VMF34	3/4"MX3/4"F	280

NUT LOCK MALE

	Cat. No.	Size	Packing
	V34M16NL	16X3/4"M	200
	V34M20NL	20X3/4"M	200
	V12M16NL	16X1/2"M	200
	V12M20NL	20X1/2"M	200

BARB MALE ADAPTOR

	Cat. No.	Size	Packing
	VM1612	16X1/2"M	400
	VM1634	16X3/4"M	350
	VM1734	17X3/4"M	350
	VM2012	20X1/2"M	400
	VM2034	20X3/4"M	350
	VM2512	25X1/2"M	260
	VM2534	25X3/4"M	280

NUT LOCK FEMALE

	Cat. No.	Size	Packing
	V34F16NL	16X3/4"F	200
	V34F20NL	20X3/4"F	200

BARB FEMALE ADAPTOR

	Cat. No.	Size	Packing
	VF1634	16X3/4"F	350
	VF1734	17X3/4"F	300
	VF2034	20X3/4"F	300
	VF2534	25X3/4"F	280

XL VALVE

	Cat. No.	Size	Packing
	V25L	25 ID x 25 ID	300
	VMM1L	1"M x 1"M	300
	V25NL	25 x 25	250

- Wide water passage for max flow rate and reduced head loss.
- Available in barb, thread and nut-lock connection.

Nut Drip - Tape Valves

Materials: Body - PP or acetal | O-Ring: EPDM | Handle - PP | Nut - PP

Threads: BSPT or NPT | Max. working pressure: 8 kg/cm²

- For tape 16&17 mm O.D
- Wall thickness 4 to 45 mil
- Tape with or without seam

CONNECTOR			
	Cat. No.	Size	Packing
		VTA	16,17X16,17

MALE ADAPTOR			
	Cat. No.	Size	Packing
		VMTA12	16,17X1/2M
	VMTA34	16,17X3/4M	300

FEMALE ADAPTOR			
	Cat. No.	Size	Packing
		VFTA34	16,17X3/4F

BARB ADAPTOR			
	Cat. No.	Size	Packing
		VTA16	16,17X16
	VTA17	16,17X17	350

P.V.C STARTER			
	Cat. No.	Size	Packing
		VGSTA	16;17 Inc. G-16

STICK STARTER			
	Cat. No.	Size	Packing
		VSTTA	16;17
	VSTTAGR	16;17 Inc. G-ST	300

Drip Tape - Nut Connectors

Materials: Body - PP or acetal | O-Ring: EPDM | Handle - PP | Ring - PP

Threads: BSPT or NPT | Max. working pressure: 8 kg/cm²

- For tape 16&17 mm O.D
- Wall thickness 6 to 25 mil - Black ring
- Wall thickness 35 to 45 mil - Brown ring
- Tape without seam

Long Ring

FEMALE ADAPTOR			
	Cat. No.	Size	Packing
		VFT34L	16.5X3/4"F

BARB ADAPTOR			
	Cat. No.	Size	Packing
		VT16L	16.5X16.5

MALE ADAPTOR			
	Cat. No.	Size	Packing
		VMT34L	16.5X3/4"M

Flat Ring

FEMALE ADAPTOR			
	Cat. No.	Size	Packing
		VFT34	16.5X3/4"F

BARB ADAPTOR			
	Cat. No.	Size	Packing
		VT16	16X16.5

MALE ADAPTOR			
	Cat. No.	Size	Packing
		VMT34	16.5X3/4"M

Flexible leakfree joint.
Minimal flow restriction.
Long life working with chemicals and out exposure.

Suitable for 32mm O.D and up.
Wall Thickness from 2mm to 5.5mm.

P.V.C. DRIPLINE START CONNECTORS SINGLE

	Cat. No.	Size	Packing
	GS12	12 mm	2000
	GS16	16 mm	1500
	GS17	17 mm	1800
	GS20	20 mm	1400
	GS25	25 mm	1200

Including G-16

NUT DRIP TAPE P.V.C STARTER

	Cat. No.	Size	Packing
	GSTA	16,17	750

Including G-16

SINGLE RING

	Cat. No.	Size	Packing
	MWG17	17;16mm (Brown Ring)	1500
	TWGT	16.5mm (Black Ring)	1500

Including G-16

RUBBER GROMMET (EPDM)

	Cat. No.	Size	Packing
	G-16	ALL SIZES	5000

ELBOW-LINE

	Cat. No.	Size	Packing
	GET	16.5 (Black Ring)	800
	GEMW16	16;17 (Brown Ring)	800

Including G-16

P.V.C. DRIPLINE START CONNECTORS SINGLE MALE THREAD

	Cat. No.	Size	Packing
	GSM12	1/2" Male	2000
	GSM34	3/4" Male	850

Including G-16

P.V.C. DRIPLINE START CONNECTORS ELBOW

	Cat. No.	Size	Packing
	GE16	16mm	1200
	GE17	17mm	1200
	GE20	20mm	1000

Including G-16

P.V.C. DRIPLINE START CONNECTORS DOUBLE Y

	Cat. No.	Size	Packing
	GY16	(Y) 16X16	2000

Including G-16

P.V.C. DRIPLINE START CONNECTORS DOUBLE T

	Cat. No.	Size	Packing
	GD16	16 mm	1000
	GD17	17 mm	1000
	GD20	20 mm	800

Including G-16

GROMMET DRILL

	Cat. No.	Size	Packing
	GD155	15.5 mm	NET
	GD160	16 mm	NET
	GD165	16.5 mm	NET

P.V.C START ASSEMBLER

	Cat. No.	Size	Packing
	GIND	ALL SIZES	NET

- Step 1 - Drill hole:
For P.V.C 16mm or 16.5mm diameter.
For P.E 15.5mm diameter.
- Step 2 - Insert rubber grommet.
- Step 3 - Moisten starter.
- Step 4 - Insert starter with P.V.C start assembler by pushing **without twisting or turning**.
- Step 5 - push leader pipe on barb connector. Do no twist or turn the starter.

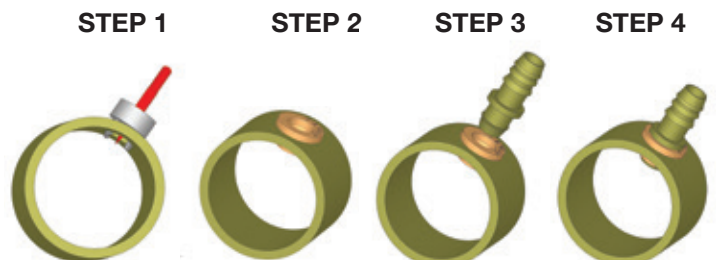

P.E. Start Connectors | Materials: Acetal for barb connector | Max. working pressure: 8 kg/cm²

For P.E. drill hole 8 mm,
For P.V.C drill hole 16 mm (with Grommet)
Maximum Wall thickness: 6mm without grommet or 3mm with grommet.

DRIPLINE STICK START CONNECTOR			
	Cat. No.	Size	Packing
	ST12	12 mm	2500
	ST16	16 mm	2000
	ST17	17 mm	2200
	ST20	20 mm	2000
	STTW	16.5mm (Black Ring)	1800
	STMW	16,17mm (Brown Ring)	1800

RUBBER GROMMET (EPDM)			
	Cat. No.	Size	Packing
	G-ST	For stick starter all size & for stq 8,10 & 12 only	8000

For P.V.C. with Rubber Grommet (G-ST)			
	Cat. No.	Size	Packing
	ST12GR	12 mm	2000
	ST16GR	16 mm	1800
	ST17GR	17 mm	1800
	ST20GR	20 mm	1600

Including G-ST

SUPER STARTER FOR P.E.			
	Cat. No.	Size	Packing
	STQ8	8 mm	4000
	STQ10	10 mm	3000
	STQ12	12 mm	3000
	STQ16	16 mm	1800
	STQ17	17 mm	1600
	STQ20	20 mm	1200

SUPER STARTER FOR P.V.C. WITH RUBBER GROMMET (G-ST)			
	Cat. No.	Size	Packing
	STQ10GR	10mm	2500
	STQ12GR	12mm	2000

SUPER STARTER PLUG			
	Cat. No.	Size	Packing
	PSS12	10, 12	12000

DRIPLINE START CONN. / BAND STARTER			
	Cat. No.	Size	Packing
	SC16	Start con. 16mm	1800
	SC17	Start con. 17mm	1600
	SC20	Start con. 20mm	1600
	SCB16	Band 16-17mm	1800
	SCB20	Band 20mm	1600
	OR188	O-Ring for 16,17mm	
	OR2110	O-Ring for 20mm	

Lay-Flat Start Connectors | Materials: Acetal for barb connector

LAY FLAT STARTER			
	Cat. No.	Size	Packing
	LFTY	16.5mm (Black Ring)	1200
	LFTA	16;17	900
	LFTA22	22	400

THREADED LAY FLAT STARTER			
	Cat. No.	Size	Packing
	LF3438	3/4" M (Punch 14 mm)	1000

OVER SIZE LF STARTER			
	Cat. No.	Size	Packing
	LF3412	3/4" M (Punch 19 mm)	1000
	LF3812	3/8" M (Punch 19 mm)	1000

FEMALE LF STARTER			
	Cat. No.	Size	Packing
	LF34F	3/4" F (Punch 14 mm)	700
	LF34FOZ	3/4" F (Punch 19 mm)	600

PP for ring connector | Max. working pressure: 8 kg/cm²

LAY FLAT SUPER STARTER			
	Cat. No.	Size	Packing
	LFS8	8 mm	2000
	LFS10	10 mm	1500
	LFS12	12 mm	1500
	LFS16	16 mm	1200
	LFS17	17 mm	1200
	LFS20	20 mm	1000

LAY FLAT PUNCHER			
	Cat. No.	Size	Packing
	PUNLF14	14mm ALL SIZE	NET
	PUNLF19	19mm OVER SIZE ONLY	NET

LAY FLAT DRIVER			
	Cat. No.	Size	Packing
	LFDRS	7mm HEX - FOR 10,12 ONLY	NET
	LFDR	10mm HEX - FOR ALL SIZES	NET

- Punch hole using LF Puncher.
For regular \varnothing 14 mm. For oversize \varnothing 19 mm
- Insert Lay Flat Starter using L.F Driver: Place the fitting nook inside the hole and turn until fully inside pipe. Hold Driver in place and tighten wing nut by hand.
- Press pipe against Lay Flat body.
- Tighten nut over pipe.



Foggers

Features:

- Incorporates a vortex design, breaking the water droplet to a fine mist.
- Modular, lightweight and easy to install, maintain and configure.
- Three part construction with O-Ring for a tight seal and leak proof.

Application:

- Mist cooling and humidifying.
- Root developmen

Technical specification:

- Material: Body - Polyester (PBT), O-Ring - EPDM.
- Nominal flow rate at 3.5 bars.
- Operating pressure: 2.5 to 5.5 bars.
- Cover Diameter: 60-120cm.
- Pattern 360°.
- Trajectory angle 80° to 100°.
- Average droplet size 60 to 100 micron.
- Recommended Filtration: 200 mesh (80 micron).

FOGGER PENDULAR

Pendular Cat no. Code: FOGCP + N + O + F + L + C

	N:	O:
	non drip valve type L, H, X, Y or N for none	Number of outlets 1, 2, 3 or 4
	F:	L:
	L/H 3, 4, 6, 8, or 12	PE tube length 30, 60 or 100 cm
	C:	
starter type P for plun or D for plun-d		
for example: FOGCPX46L30P - fogger pendular 4 outlets 6 L/H, with 30 cm tube, with NDV x and plun		

NON DRIP DEVICE

	Cat. No.	Size	Packing
	530-X	6M/F	4000
	Material: Acetal Opening pressure - 2.5 bar Closing pressure - 1.5 bar		

FOGGER MALE ADAPTOR THREAD

	Cat. No.	Size	Packing
	A12A	1/2 NPT	2500
	A38	3/8 BSPP	3200

FOGERS

	Cat. No.	Size	Packing
	FOG3L	3 L/H Purple	5000
	FOG4L	4 L/H Black	5000
	FOG6L	6 L/H Green	5000
	FOG8L	8 L/H Brown	5000
FOG12L	12 L/H Grey	5000	

FOGGER MALE ADAPTOR

	Cat. No.	Size	Packing
	MC47E	4/7	20000

FOGGER CROSS CAP

	Cat. No.	Size	Packing
	CFFA	Cap	15000

FOGGER FEMALE ADAPTOR

	Cat. No.	Size	Packing
	FC47E	4/7	16000

FOGGER CROSS

	Cat. No.	Size	Packing
	CFFGA	Cross	2400

4/7 MALE ADAPTOR

	Cat. No.	Size	Packing
	A3847	3/8"MX4/7 Barb	10000

Flow rates (L/H) versus pressure (bar), single head:

Nozzle Color	Nozzle size (micron)	Nominal flow L/H RATE	2.5 bar	2.8 bar	3.2 bar	3.5 bar	3.9 bar	4.2 bar	4.6 bar	4.9 bar
Purple	26	3	2.9	3.1	3.2	3.3	3.3	3.4	3.4	3.6
Black	33	4	3.3	3.5	3.8	3.9	4.1	4.3	4.4	4.6
Green	51	6	5.2	5.7	5.8	6.0	6.2	6.5	6.6	6.9
Brown	63	8	6.4	6.9	7.3	7.7	7.9	8.3	8.6	8.8
Gray	89	12	9.2	9.9	10.6	11.1	11.5	12.0	12.4	13.0



SPRINKLER SOCKET

	Cat. No.	Size	Packing
	FC12N	1/2"X1/2"	700
	FC34N	3/4"X3/4"	500
	FC1234N	1/2"X3/4"	800
	FC134N	1"X3/4"	400

ADJUSTABLE RISER

	Cat. No.	Size	Packing
	ADRS34	3/4"M X 1/2"-3/4"	150
	ADRS1	1"M X 1/2"-3/4"	150

Length: 11-19 cms

ANTI THEFT RISER M/F

	Cat. No.	Size	Packing
	AMF12AT	1/2" M/F	600
	AMF34AT	3/4" M/F	350
	AMF1AT	1" M/F	200

ADJUSTABLE RISER

	Cat. No.	Size	Packing
	ADRL34	3/4"M X 1/2"-3/4"	100
	ADRL1	1"M X 1/2"-3/4"	100

Length: 18-29 cms

ANTI THEFT ELBOW M/F

	Cat. No.	Size	Packing
	EMF12AT	1/2" M/F	500
	EMF34AT	3/4" M/F	300
	EMF1AT	1" M/F	200

EAZY PIPE MALE ADAPTOR

	Cat. No.	Size	Packing
	NC12A	1/2"	2000
	NC34A	3/4"	1300

SWING JOINT

	Cat. No.	Size	Packing
	SJ12150	1/2"X150x1/2	50
	SJ34150	3/4"X150X3/4"	40
	SJ1250	1"X250X1"	20

EAZY PIPE MALE ELBOW ADAPTOR

	Cat. No.	Size	Packing
	NEC12A	1/2"	1500
	NEC34A	3/4"	1200

BUTTERFLY BRASS VALVE BOX

	Cat. No.	Size	Packing
	BOXBFV	3/4"M	30

BUTTERFLY PP VALVE BOX

	Cat. No.	Size	Packing
	BOXBFVP	GARDEN HOSE QUICK CONNECTOR	30



Sprinklers & sprayers accessories

MINI VALVE

	Cat. No.	Size	Packing
 MVA35	MVA35	3/5X3/5	5000
	MVA47	4/7X4/7	5000
	MVADS	DAN	5000
	MV475	4/7M X 5 mm	5000
 MV476	MV476	4/7M X 6 mm	5000
	MV5MF	5M X 5F	5000
 MV6MF	MV6MF	6M X 6F	5000
	MV475		

Material:
Body-acetal
Handle-HDPE

SUPER STARTER FOR P.E.

	Cat. No.	Size	Packing
 STQ8	STQ8	8 mm	4000
	STQ10	10 mm	3000
	STQ12	12 mm	3000
	STQ16	16 mm	1800
	STQ17	17 mm	1600
	STQ20	20 mm	1200
 STQ12ME	STQ12ME	12 mm	3500

RUBBER GROMMET (EPDM)

	Cat. No.	Size	Packing
 G-ST	G-ST	For stick starter all size & for stq 8,10 & 12 only	8000

SPRINKLER ADAPTOR

	Cat. No.	Size	Packing
 AF838	AF838	3/8"F X 8 Barb	3000
	AF812	1/2"F X 8 Barb	1000
	AF1012	1/2"F X 10 Barb	800
	AF1212	1/2"F X 12 Barb	800

For metal rod 6 or 8 mm

Cat code	Sprinkler stand Assembly
AGST812L12	Sprinkler adaptor 8x1/2", 120 cm PE tube, super starter 8mm
AGST812L17	Sprinkler adaptor 8x1/2", 170 cm PE tube, super starter 8mm
AGST1012L12	Sprinkler adaptor 10x1/2", 120 cm PE tube, super starter 10mm
AGST1012L17	Sprinkler adaptor 10x1/2", 170 cm PE tube, super starter 10mm
AGST1212L12	Sprinkler adaptor 12x1/2", 120 cm PE tube, super starter 12mm
AGST1212L17	Sprinkler adaptor 12x1/2", 170 cm PE tube, super starter 12mm

* For metal rod 6mm or 8 mm

AGRI STAND

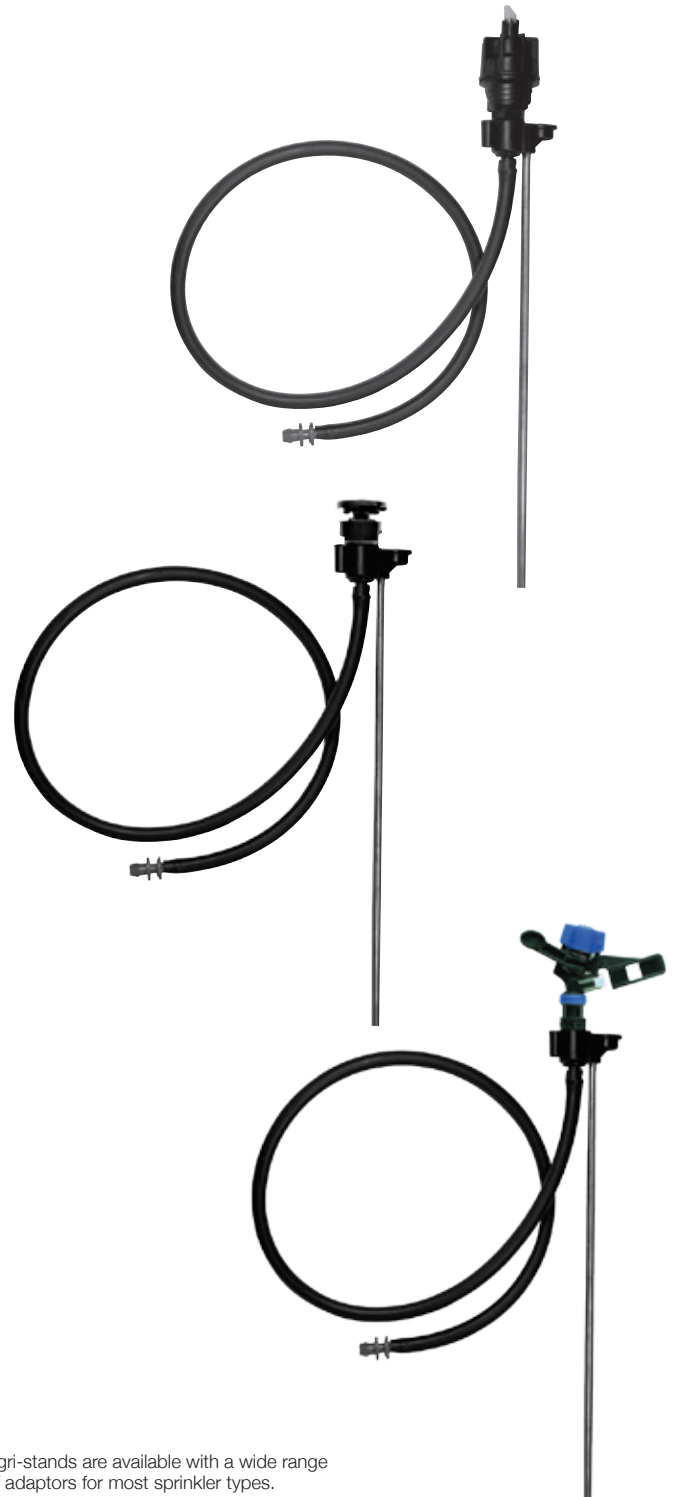



Agri-stands are available with a wide range of adaptors for most sprinkler types.

Dripper Accessories

Drip Kits

MICRO TUBE ADAPTOR*			
	Cat. No.	Size	Packing
	A35	3/5	50000
	A46	4/6	50000

CAP FOR WOODPECKER DRIPPERS*			
	Cat. No.	Size	Packing
	DHP		10000

DRIP SPIKE			
	Cat. No.	Size	Packing
	DSP	3/5	4000
	Leads drop to spike bottom – direct to plant roots For greenhouses and nurseries, inserted in pots and grow-bags		

LABYRINTH DRIP SPIKE			
	Cat. No.	Size	Packing
	DSPL	3/5	2500
	<ul style="list-style-type: none"> • Can function as stand alone dripper • Flow rate at 1.0 bar 1.5 l/h • Labyrinth inlet serves as integral filtration • Serve as flow equalizer from multi-outlet drippers • For greenhouses and nurseries, inserted in pots and grow-bags 		

NIPPLE CONNECTOR			
	Cat. No.	Size	Packing
	N35	3/5mm	45000

MICRO DRIP MANIFOLD*			
	Cat. No.	Size	Packing
	MA40L	4 OUTLETS 3/5	9000

MICRO DRIP ADAPTOR CROSS*			
	Cat. No.	Size	Packing
	AX35	3/5	15000

MICRO DRIP ADAPTOR ELBOW*			
	Cat. No.	Size	Packing
	AE35	3/5	32000

MICRO DRIP ADAPTOR T*			
	Cat. No.	Size	Packing
	AT35	3/5	20000

DRIP KITS	
Cat Code	Assembly
KIT1	Labyrinth drip spike PE micro tube 3/5 length 80cm
KIT2	Labyrinth drip spike Manifold fitting 2 outlets PE micro tube 3/5 length 80cm
KIT4	Labyrinth drip spike Manifold fitting 4 outlets PE micro tube 3/5 length 80cm
KIT2-80VD	Labyrinth drip spike Manifold fitting 2 outlets PE micro tube 3/5 length 80cm PC dripper Mini valve 5M/F
KIT4-80VD	Labyrinth drip spike Manifold fitting 4 outlets PE micro tube 3/5 length 80cm PC dripper Mini valve 5M/F
Other assemblies available on request	

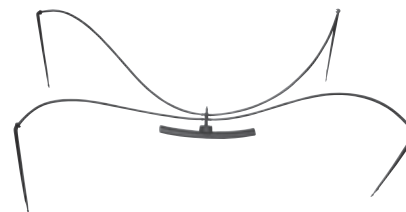

ASSEMBLY

P.C Dripper
Manifold 4 Outlet 3/5
Micro Tube 3/5
4 Labyrinth Drip Spike

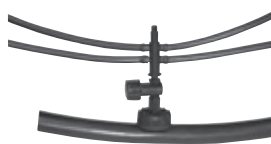

ASSEMBLY

P.C Dripper
Mini Valve 5M/F
Manifold 4 Outlet 3/5
Micro Tube 3/5
4 Labyrinth Drip Spike



ASSEMBLY

P.C Dripper
Micro Tube 3/5
Drip Spike





ASSEMBLY

P.C Dripper
Mini Valve 4/7 x 5
Manifold 4 Outlet 3/5
Micro Tube 3/5
4 Labyrinth Drip Spike

* For 6 mm dripper (other sizes available upon request)

Drip Line Accessories

PIPE STABILIZER			
	Cat. No.	Size	Packing
	PPSNTL	16-17	1000

PIPE STABILIZER STAKE			
	Cat. No.	Size	Packing
	PEGP	16,17	2000

SUPPORT HOOK			
	Cat. No.	Size	Packing
	SH16	16	3000
	SH20	20	2000

TIE BAND			
	Cat. No.	Size	Packing
	TB	300mm Length	3000

END LINE 8 FIGURE			
	Cat. No.	Size	Packing
	ELP16E	16	2500
	ELP20E	20	1400

Micro Drip Accessories

STABILIZER PEG			
	Cat. No.	Size	Packing
	SP35	3/5-4/6	10000

MICRO DRIP COUPLING			
	Cat. No.	Size	Packing
	C6	6X6	32000

MICRO DRIP T			
	Cat. No.	Size	Packing
	TC6	6X6X6	10000

MICRO DRIP ELBOW			
	Cat. No.	Size	Packing
	E6	6X6	10000

MICRO DRIP CROSS			
	Cat. No.	Size	Packing
	CX6	6X6X6X6	5000

HOLE PLUG			
	Cat. No.	Size	Packing
	HP5	5 mm	60000
	HP8	8 mm	30000

METAL PUNCHER			
	Cat. No.	Size	Packing
	MPUN	3mm	NET

PLASTIC PUNCHER			
	Cat. No.	Size	Packing
	PPUN	3mm	NET



13 Nahal Snir St.,
North industrial zone,
Yavne, Israel 81224
Tel: +972-8-9328010
Fax: +972-8-9328020
www.tavlit.co.il
export@tavlit.co.il

